

# PROLINE

SYSTEMS FOR BALCONY AND PATIO



Our outdoor  
playlist on  
YouTube



## BALCONY & PATIO



# Index

## AT A GLANCE

### PROSTILT

Pedestal and slab supports **12 - 17**

### PROSTILTadvance 2.0

Aluminium substructure system **18 - 23**

## DETAILED SOLUTIONS

PROSTILT **14 - 15**

PROSTILTadvance 2.0 **22 - 23**

### PROCODRAIN

Drainage systems **26 - 29**

### PROCOFORM & PROFORM

Balcony and patio profiles **30 - 33**

### PROCOLINE

Drainage channels **34 - 37**

## DETAILED SOLUTIONS

PROCODRAIN **28 - 29**

PROCOLINE **36 - 37**

HERE YOU WILL FIND OUR  
PATIO CONFIGURATOR



# PROSTILT

## PEDESTAL AND SLAB SUPPORTS

### THE MOST IMPORTANT FACTS

- For outdoor ceramic, natural stone, artificial stone
- Weather-resistant
- Maintenance-free and durable
- Very high load capacity
- Fast and simple laying (without special tool)
- Accessories for drainage, facing etc.



HERE YOU WILL  
FIND OUR PROJECT





PROLINE

Terrassen mit  
**STELZLAGERN**  
einfach gestalten!



The figure shows a special design.

PROLINE

Terrassensanierung mit  
**STELZLAGERN**  
bei Miriam Jacks

A video advertisement for PROLINE STELZLAGERN. The video shows a man in a green shirt pointing at a black metal frame. The text 'Terrassensanierung mit STELZLAGERN bei Miriam Jacks' and the PROLINE logo are visible.

# PROSTILTadvance 2.0

## ALUMINIUM SUBSTRUCTURE SYSTEM

### THE MOST IMPORTANT FACTS

- Extremely high capacity (also for commercial and public areas)
- Combined laying with patio decking, WPC, outdoor ceramic, natural stone
- Weather-resistant
- Maintenance-free and durable
- Simple laying (without special tool)
- Accessories for drainage, facing etc.

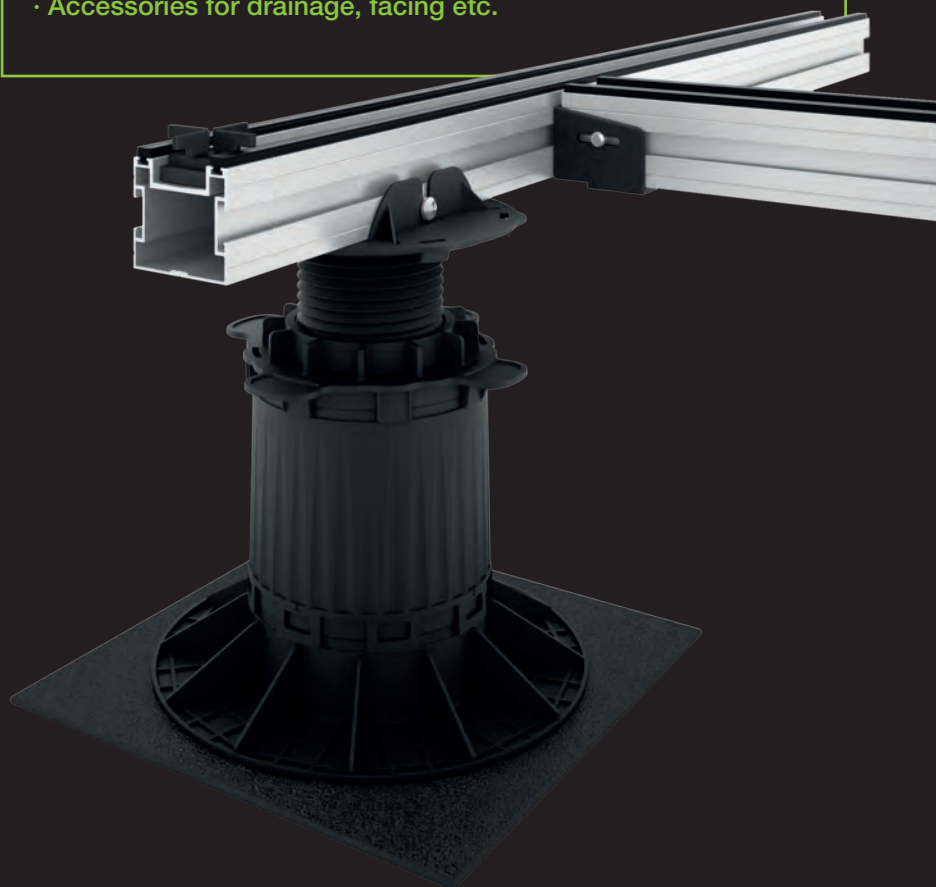

HERE YOU WILL  
FIND OUR PROJECT







# Designing the patio

## WITH OUR PATIO CONFIGURATOR

Professional patio planning made easy: With the PROLINE patio configurator, you can configure any project accurately in advance, and have it checked by our sales technician, so that detailed or special solutions can be directly adjusted as required, following close consultation. Once the configuration is finalised, you will be shown the material required for realising the project, which can be easily ordered once the project is approved. You quickly get a customised configuration for every individual patio situation, and can start building immediately. You will see: The PROLINE patio configurator elevates patio planning to a new level!

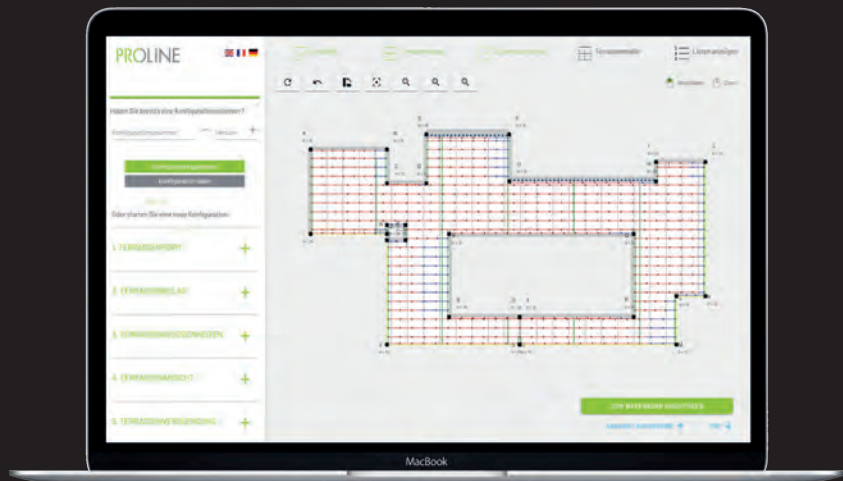

HERE YOU WILL FIND OUR  
PATIO CONFIGURATOR



## Overview

PEDESTAL AND SLAB SUPPORTS, ALUMINIUM SUB-STRUCTURE SYSTEM, VISUAL PROTECTION ELEMENTS



**PROSTILT**  
PEDESTAL AND  
SLAB SUPPORTS

**P. 12 - 17**



**DETAILED  
SOLUTIONS**

PROSTILT

**P. 14 - 15**

PROSTILTadvance 2.0

**P. 22 - 23**

**PROSTILadvance 2.0**  
ALUMINIUM SUBSTRUCTURE  
SYSTEM

**P. 18 - 23**

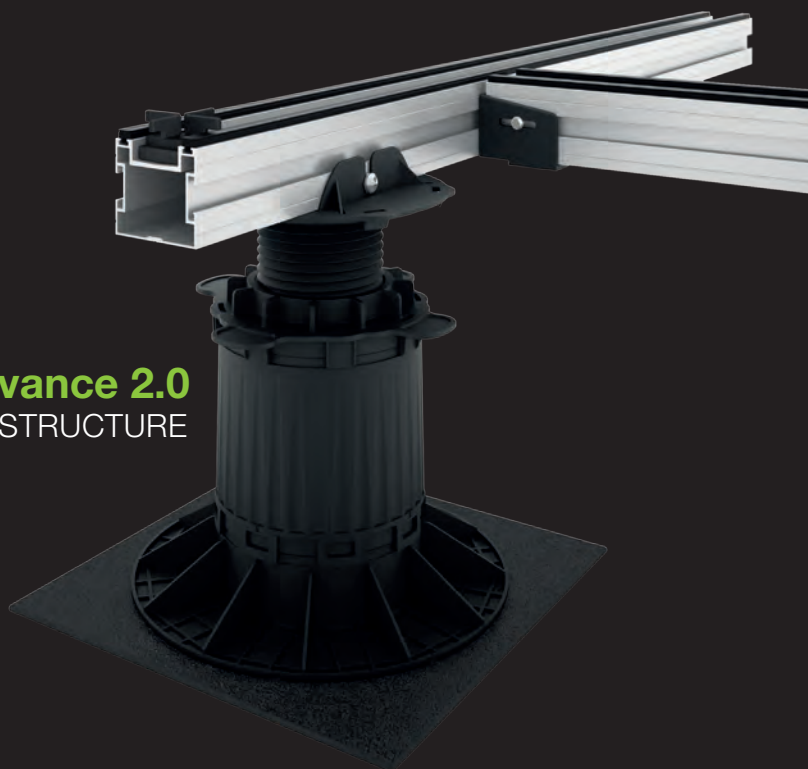



PROST

# PROSTILT

## PEDESTAL AND SLAB SUPPORTS

With pedestal supports, new areas can be created for patios, where this has long been impossible up to now for structural reasons. The system thus provides craftsmen and planners with a high-quality solution, to make outdoor areas perfect, without the need to remove large quantities of subsoil when building patios and carry out comprehensive compression work. For this reason, high-quality patio coverings made of ceramic, concrete or natural stone slabs are increasingly being installed on pedestal supports these days.



### High pressure-resistance

The adjustable foot is in an extremely stable design with a maximum load capacity of 1.2 t



### Tilt stability / load distribution

Optimum stability thanks to the support foot with a diameter of around 200 mm



### Variable installation heights

Feet adjustable to different heights with variable adjustment ranges provide an installation height range between 11 and 370 mm



### Fine adjustment

Simple and fast installation due to practically-orientated adjusting screw



### Side facing / accessories

Stainless steel profile and drainage channel

# PROSTILT in detail

ACCESSORIES FOR FACING, DRAINAGE ETC.

## PROSTILT with facing\*

Two clips have been developed to hold the PROSTILT facing profile (A). The lower clip (B) is positioned below the pedestal support and holds the riser in the lower area. The upper clip (C) is laid on the plate of the pedestal support and is held by the joint bridges. It fastens the cut riser to the upper edge. The upper clip also has an intake bridge (D), on which the facing profile is hung. To fix the facing profile we recommend glueing it at points using OTTOCOLL M500 hybrid adhesive. The facing profile can be shortened in length if necessary.

WOULD YOU LIKE INSTRUCTIONS?

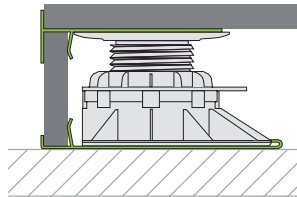

\*Caution: To use the facing solution, a mechanical attachment of the outer rows of pedestal support with the subsurface must be ensured.

## PROSTILT with spacer

The PROSTILT clip spacer with neoprene pad (A) can be used in the edge area of roof terraces, for example, for the transition between the patio and the masonry. This is placed on the upper side of the plate and held by the joint bridges. The spacer forms a consistent 10 mm thick joint to the wall or to the end of the roof terrace. This ensures that the seal of the roof terrace does not sustain any damage even if the surface expands or there is movement in the upper material.

WOULD YOU LIKE INSTRUCTIONS?

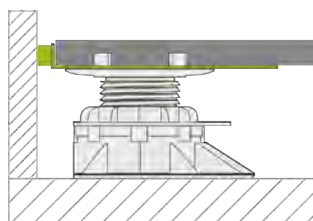

More information as well as detailed technical drawings are available in the download area of our website.



## PROSTILT with drainage channels

Whenever snow or standing water is to be drained away from the house, PROSTILT drainage channels are being used. The PROSTILT drainage set (A) is either installed directly or slightly offset from the window with spacer tiling. This is achieved by fitting the channel onto half of the adjustable base plate and screwing it down. A suitable connecting tile is laid on one side or either side of the channel. The drainage channel is flush-mounted at the same installation height. At 20 mm installation height, the channels optimally adapt to the conventional slab strength in the outdoor area. The PROSTILT drainage channels with a width of 150 mm correspond to the requirements of channels in accordance with the flat roof guideline.

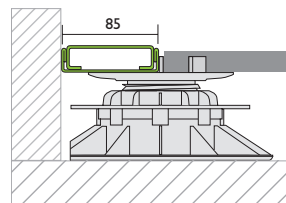

WOULD YOU LIKE INSTRUCTIONS?



The figure shows a special design.

## PROSTILT in the edge area

### With concrete kerbs

The most common form of flush installation up to now has been the connection to kerbs. In the transition area of kerb and ceramic, however, there are frequent problems due to material movements. The PROSTILT clips with spacer protect the ceramic and fix the slab towards the border.

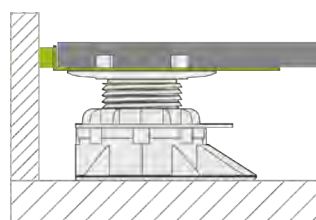

### With PROFORM TOS T- profile

A second solution is offered by the PROFORM TOS balcony and patio profiles at low installation heights. With the installation the punched support base is fixed to the plate of the pedestal support and is later also held by the plate's own weight. The 75 mm high gives an attractive shape and finish to the patio area. For this, it must be ensured that the pedestal supports can be mechanically attached to the subsurface.

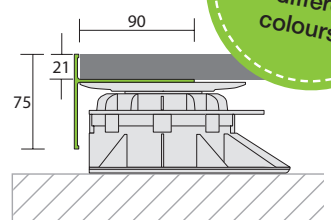
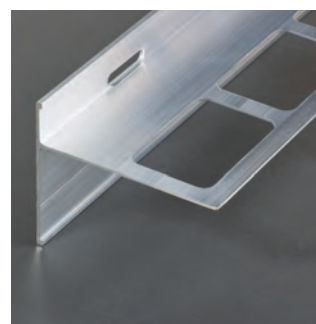

The profile is available in different colours!

# PROSTILT

## PEDESTAL SUPPORTS – TYPES OF LAYING AND PLACEMENT

### Cross joint

60 x 60 cm

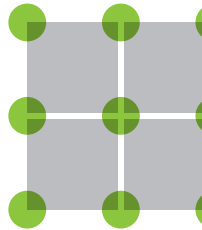

120 x 60 cm

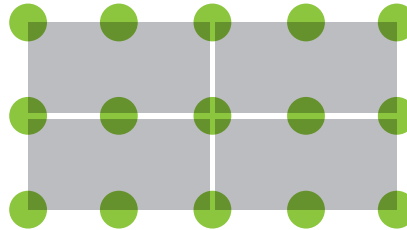

100 x 100 cm

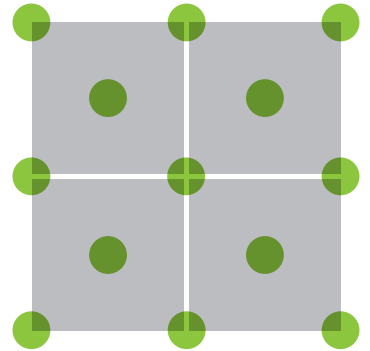

### Half-offset

60 x 60 cm

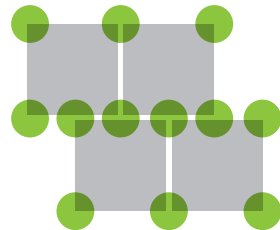

120 x 60 cm

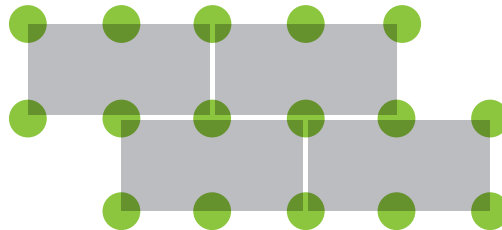

### Running

120 x 30 cm

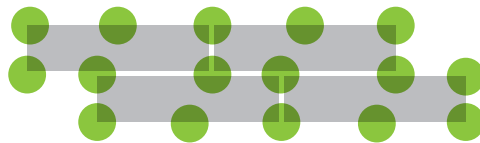

If the axial dimension of the slabs to be laid is more than 60 cm, the slab is to be laid in the axis with additional pedestal supports.



HERE YOU WILL FIND OUR  
PATIO CONFIGURATOR





# PROSTILT

## SLAB SUPPORTS

PROSTILT slab supports can be used anywhere where heavy patio slabs made of concrete or natural stone are to be laid on even surfaces. Old patio coverings that have become unsightly can be simply overbuilt using PROSTILT slab supports. Even joints of professional quality can be quickly and simply achieved using the slab supports.

The slab supports consist of soft rubber and have a burled underside as well as an integrated joint bridge on the top side. The elasticity of the material makes the direct laying of PROSTILT slab supports possible on bituminous sheeting\*, for example, without damaging this.

### Diagrammatic construction of patio slab laying on slab supports

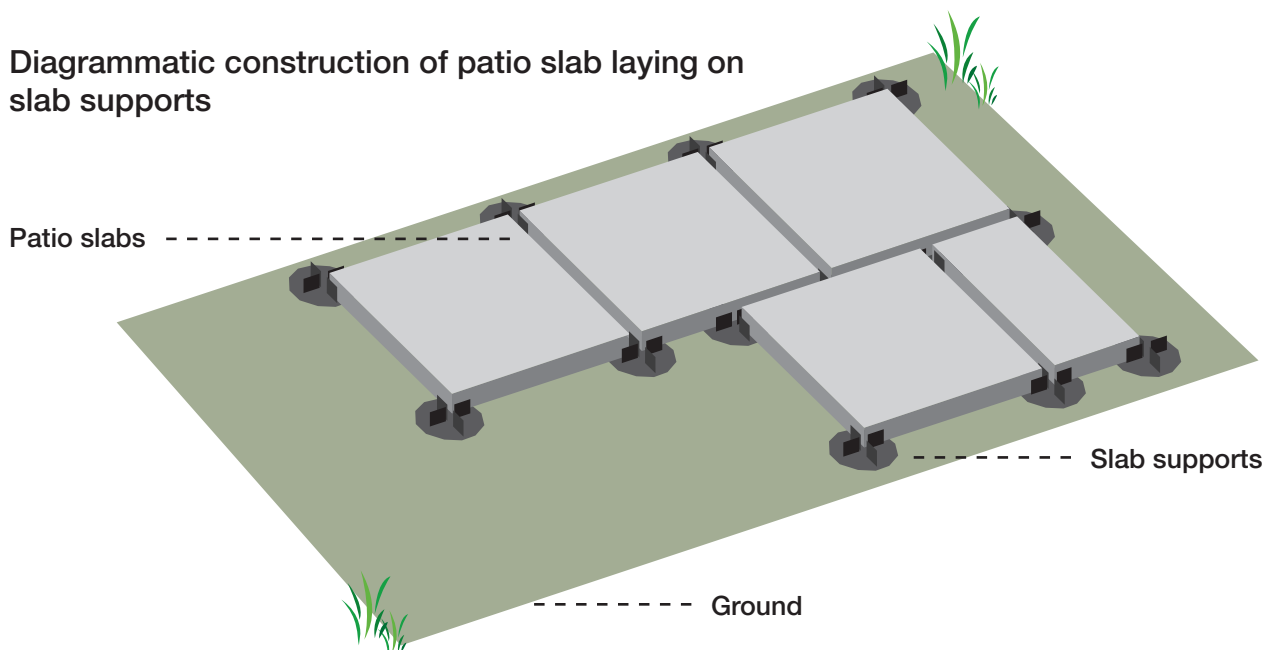

\*In connection with PROSTILT rubber granulate pad



**PROSTILT slab profiles**  
10 mm and 20 mm



**PROSTILT Compensation disc** for slab plates Ø120 mm

### THE MOST IMPORTANT FACTS

- Slab supports are produced in Germany
- Available at heights of 10 and 20 mm
- Easy to process: Corner and edge pieces can be broken off easily
- High stability due to large laying surface
- Compensation of minor height differences using compensation discs
- Drainage through open joints
- Frost damage is avoided due to decoupling



PROSTILTadvanc

# PROSTILTadvance 2.0

## ALUMINIUM SUBSTRUCTURE SYSTEM

With PROSTILTadvance 2.0, you are using the best from two areas to build a permanent solution without fuss or quibble: Variable, ultra strong pedestal supports form the flexible and easy to handle basis of your patio. This then carries a support structure of aluminium sections. This results in optimum rigidity of the base as well as exceptionally high load-bearing capacity, which makes PROSTILTadvance 2.0 ideally suited to commercial and public areas.



### Floorboards and slabs

Suitable for different materials:  
patio decking, WPC, ceramic, natural stone



### Change of floor covering possible

Combined laying possible, e.g. between wood / ceramic



### Different patio shapes

Complete freedom in designing the patio



### High load capacity

Substructure can take loads up to 5 kN/m<sup>2</sup>



### Invisible screw connection

Visually attractive end result

# PROSTILTadvance 2.0

FOR WOODEN DECKING BOARDS, OUTDOORS  
CERAMIC AND NATURAL STONE

The best concept for the design of a permanently attractive patio is: Even load distribution. This is the benefit of using PROSTILTadvance 2.0, the aluminium support structure for patios with system. The support structure is finally positioned with the support profiles on the PROSTILTadvance 2.0 adjustable feet, which can vary between 11 and 370 mm. This ensures that even surfaces can be designed and implemented without disruptive variations in height.



1

Invisible screw connection of floorboards with a groove with our PROSTILT-advance 2.0 T-support. The clip works like a connection element, which is screwed into the substructure between the boards, thus fixing the adjacent boards in place. Advantage: Not a single screw is visible on the surface and the floor covering is consequently not damaged.



2

The traditional fixing of the decking boards to the substructure by means of screws. For this purpose, the support profile is rotated by 180 degrees during laying, the PROSTILTadvance 2.0 spacer clip is screwed to the support profile with the floor covering. The spacer clip enables complete ventilation underneath, thus preventing waterlogging.



3

For the laying of outdoor ceramic or natural stone, we have developed the PROSTILTadvance 2.0 cross-clip. The glass-fibre-reinforced plastic clip is inserted into the support profile, and is suitable for slabs from a thickness of 20 mm. You can thus achieve an even look of the joints with 3 mm distance between the slabs.

1





2

3

# PROSTILTadvance 2.0 in detail

ACCESSORIES FOR FACING, DRAINAGE ETC.

## PROSTILTadvance 2.0 Facing with edge profile and top clip

To achieve a clean finish for a patio, a retaining clip (A) is screwed onto the top of the support profile, which can receive the top part of the facing. The bottom part of the facing is girded by the PROSTILT U-profile (B) and adjusted by means of a countersunk head screw on the concrete edge. The profile is punched every 50 cm for this purpose in the factory. The top clip and U-profiles can thus receive facing that is 2 cm in thickness. Optionally, the vertical joint can be covered by the facing profile (C).

WOULD YOU LIKE INSTRUCTIONS?

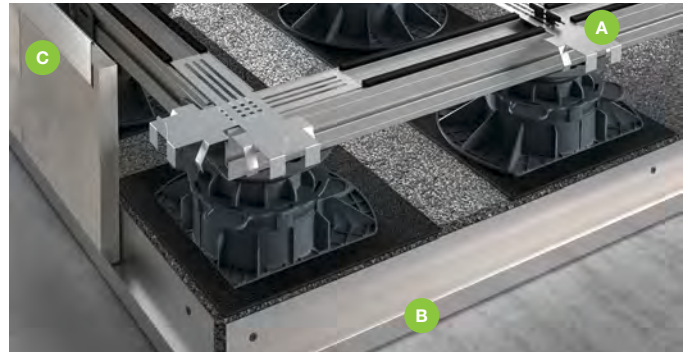
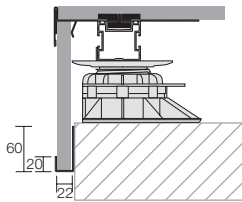

## PROSTILTadvance 2.0 Facing with edge profile bracket and connection bracket

By using the edge profile bracket in connection with the connection bracket L (B), support profiles (A) can also easily and quickly be connected together vertically. In combination with the top clip (C) and the start and end holder, this creates a stable substructure for vertical facing. (Graphic shows the processing of WPC boards with groove)

WOULD YOU LIKE INSTRUCTIONS?

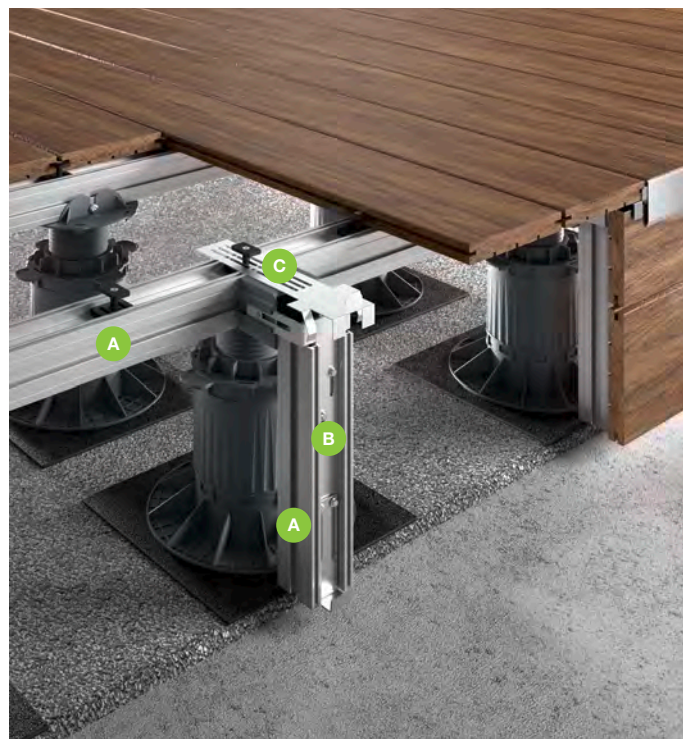

More information as well as detailed technical drawings are available in the download area of our website.



## PROSTILTadvance 2.0 Facing with TOS T-profile

With the facing version with the TOS T-profile (A) in combination with the PROFORM W-profile (B), visually attractive facings for the edge area can be realised quickly. By using these profiles, the complex cutting of ceramic strips for facing is no longer required, for example.

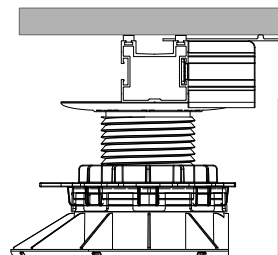

WOULD YOU LIKE INSTRUCTIONS?



Additional drainage channels can be found in our outdoor price list.

## PROSTILTadvance 2.0 with drainage channels

Whenever snow or standing water is to be drained away from the house, PROSTILT drainage channels are (A) being used. The channels are screwed to the supplied stainless steel screws on the PROSTILTadvance 2.0 substructure. At 20 mm installation height, the channels optimally adapt to the conventional slab strength in the outdoor area. The PROSTILT drainage channels with a width of 150 mm correspond to the requirements of channels in accordance with the flat roof guideline.

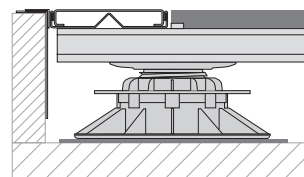

WOULD YOU LIKE INSTRUCTIONS?



The figure shows a special design.

# OVERVIEW

DRAINAGE SYSTEMS, BALCONY AND PATIO PROFILES AND DRAINAGE CHANNELS



**PROCODRAIN**  
DRAINAGE SYSTEMS  
S. 26 - 29



**PROCOLINE**  
DRAINAGE CHANNELS  
S. 34 - 37



## PROCOFORM & PROFORM

BALCONY AND PATIO PROFILES

S. 30 - 33

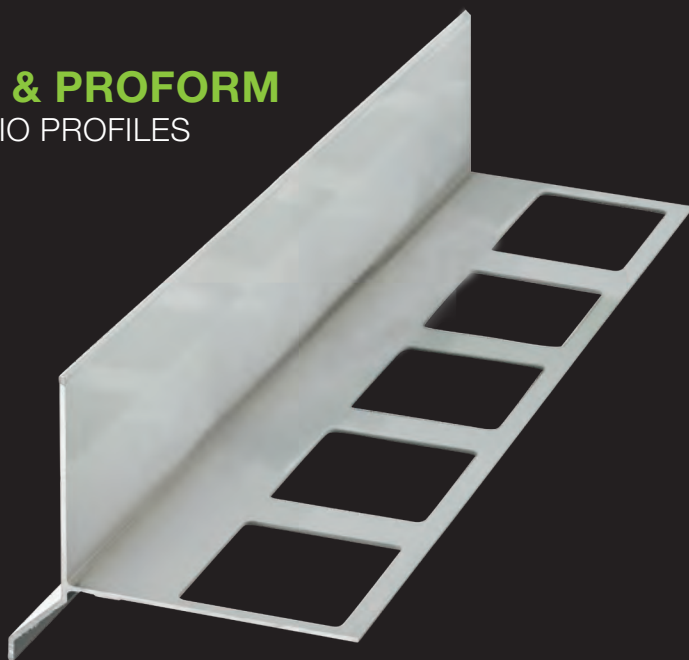



PROCCODR

# PROCODRAIN

## DRAINAGE SYSTEMS

In order to protect outdoor floorings optimally against weather influences, the use of functional drainage systems is recommended. PROCODRAIN guarantees powerful drainage, reliable protection against contamination and perfect ends. Protected like this, outdoor floorings still continue to shine perfectly after hard winters.



### Load distribution / protection of the sealing

Protective effect on the sealing corresponds to DIN 18195



### Load-bearing capacity

25 t/m<sup>2</sup> at 8 mm nap height  
18 t/m<sup>2</sup> at 20 mm nap height



### Impact sound reduction

Noise transmissions are noticeably reduced



### Anti-frost cracking\*

Applies to PROCODRAIN E and PROCODRAIN GK

\*By using the PROCODRAIN E or PROCODRAIN GK decoupling system, fast drainage of rain or melt water to the second drainage level is ensured. With the swift water drainage, the coverings dry faster, and there is no damage following alternating freezing/thawing.

R  
A  
I  
N

# PROCODRAIN in detail

## DRAINAGE SYSTEMS

### PROCODRAIN E

With PROCODRAIN E, we provide a stable indented film for all floor coverings laid on screed floor. Highly dense polyethylene (HDPE) renders the film particularly resistant. The MED filter fleece, which is laminated onto the naps, creates a second drainage level. This level below the floorings ensures fast drainage of the water.

PROCODRAIN E impresses with particularly high load-bearing capacity and resistance. Temperature fluctuations and frost is easily handled by this high-quality HDPE indented film. The great load-bearing capacity of these drainage mats makes PROCODRAIN E your perfect partner with regard to the drainage of used paths and driveways.

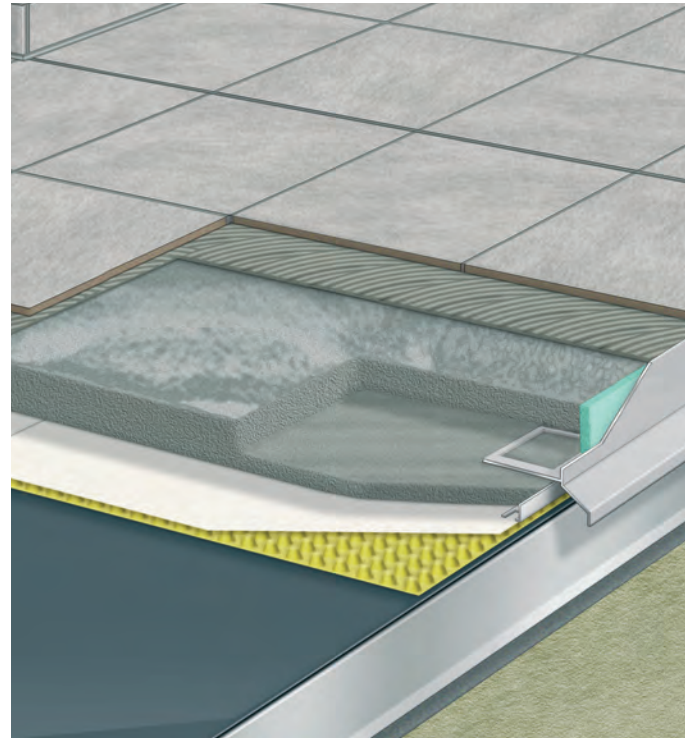

### PROCODRAIN GK

PROCODRAIN GK is a drainage mat with pedestal support, which impresses when laying in the coarse-grain screed floor or coarse-grain mortar. The indented film is covered by a sturdy textile lattice, which perfectly and quickly drains water, prevents the build-up of layers functioning as water barriers and supports the floor coverings above.

With regard to water collection and contamination by grout grains, coarse-grain screed floors and coarse-grain grout place specific demands on a drainage mat. PROCODRAIN GK has been specifically developed for this application. Depending on conditions and water quantities to be expected, this drainage mat is available with two nap heights (= 8 mm and 20 mm).

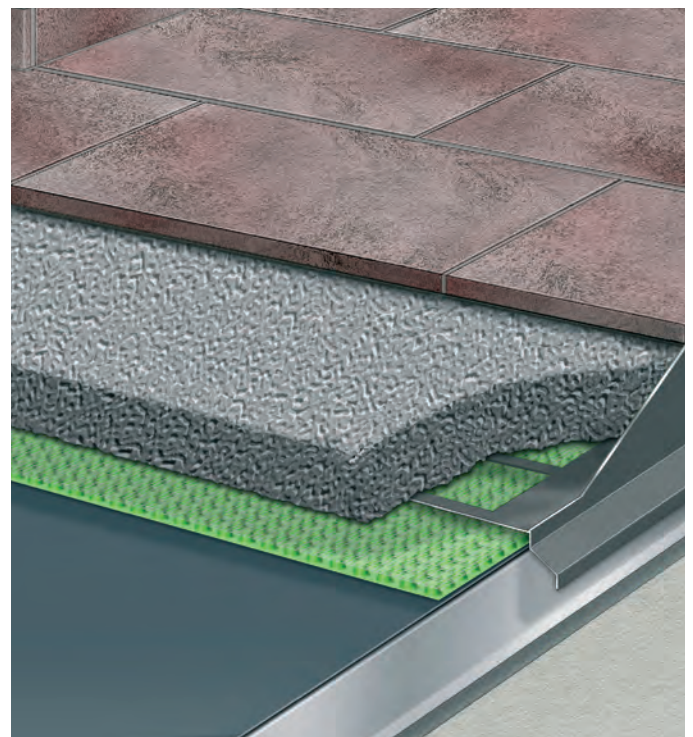



## PROCODRAIN S

PROCODRAIN S is an HDPE indented film with pedestal support with top-sided PP fleece. Due to the stability of the fleece, PROCODRAIN S is particularly suited to loosely laid floorings made of concrete, natural and cast stone tiles, ceramic elements or narrow-joint wooden structures on loose grit or gravel fill. One issue for loosely laid floorings is organic proliferation and weed infestation. You can reduce this effectively and sustainably with the PROCODRAIN S drainage films. In addition, PROCODRAIN S has a protective effect on the sealing film below and reduces mechanical strains.



## PROCODRAIN E SV, PROCODRAIN S SV and PROBAND L

Of course you will also receive the butt-jointing tape respective to one of the three drainage systems.

- The three versions consist of the same fleece and grid materials of the drainage web and thus guarantee the same safety and function with regard to impacts.
- With self-adhesive fix.
- To establish durable and guaranteed butt joints.
- The practical width of 15 cm ensures a perfect bottom roll safety.
- One roll houses 20 m (PROCODRAIN E SV and S SV) or 25 m (PROBAND L) butt-jointing tape.



PROCCOFO  
& PROFO

# PROCOFORM & PROFORM

## BALCONY AND PATIO PROFILES

Weather conditions place a major strain on edges and corners, particularly for balconies and patios. The balcony and patio profiles PROCOFORM and PROFORM provide effective protection. They are moulded from aluminium and stainless steel, available in different colours and perfectly adapted to the PROCODRAIN drainage systems.



ORM  
ORM

# PROCOFORM & PROFORM

## BALCONY AND PATIO PROFILES

### PROCOFORM K

Individually implementable angle profile in concrete, coarse-grain and reacting resin screeds as well as gravel fills, which are laid with tile, slab, natural stone and concrete stone coverings.

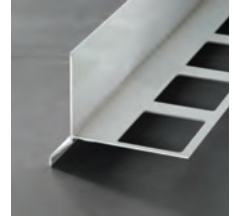
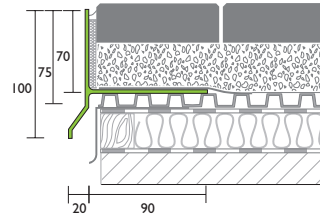

### PROCOFORM WSE

Individually implementable angle profile in concrete, coarse-grain and reacting resin screeds with tile, slab or natural stone coverings.

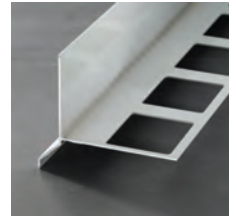
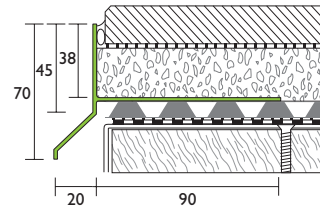

### PROCOFORM WSE F-S

Individually implementable angle profile under reacting resin screed, specifically suited to direct linking of compound seals.

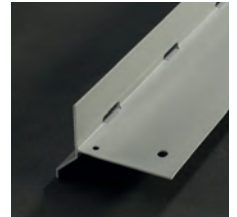
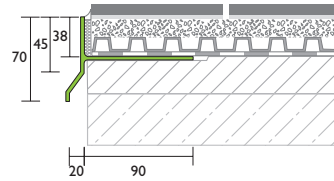

### PROFORM WSD

Individually usable angle profile for thin-bed laying.

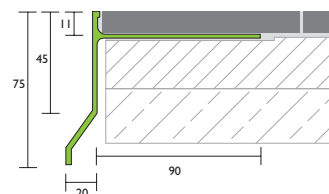

### PROFORM WSD F-S

Individually implementable angle profile for thin-bed laying, specifically suited to direct linking of compound seals.

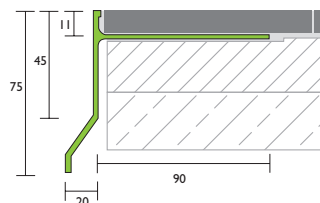



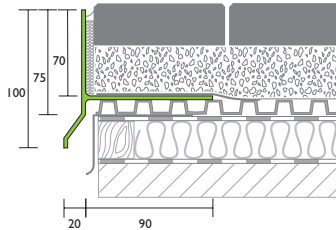
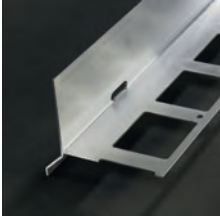

## PROFORM K

Individually implementable angle profile for concrete, coarse-grain and reacting resin screeds as well as gravel fills, which are laid with tile, slab, natural stone and concrete stone coverings.

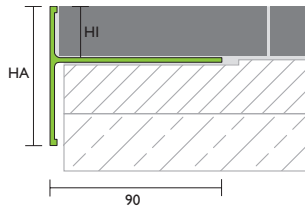

## PROFORM TE

Individually usable angle profile for medium- and thin-bed laying, available in heights 55 mm (HA = external dimensions) and 15 mm (HI = internal dimensions), as well as 75 mm (HA) and 24 mm (HI).

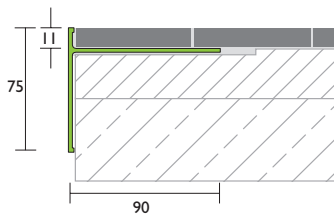
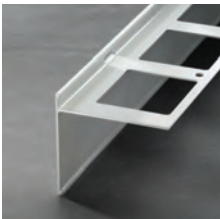

## PROFORM TD

Individually usable angle profile for thin-bed laying.

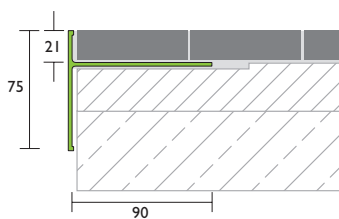

## PROFORM TOS

Individually usable angle profile for thin-bed laying of outdoor ceramic.

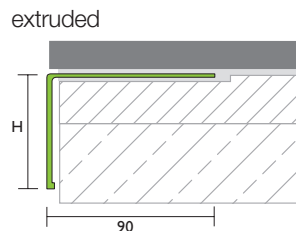
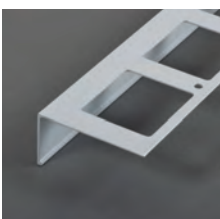

## PROFORM W

Individually usable angle profile, available in the following heights: 40, 55, 75, 95, 120 and 150 mm.

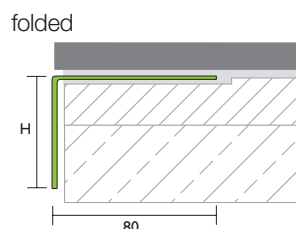



PROCOL

# PROCOLINE

## DRAINAGE CHANNELS

When it comes to drainage, transitions between outdoor floorings and interiors are a sensitive area. Waterlogging can occur quickly in case of heavy rain in front of doors, windows and walls. In addition, wind and driving rain quickly drive the surface water in direction of the living area. PROCOLINE drainage channels effectively drain large quantities of water into the subsurface.

LINE

# PROCOLINE in detail

## DRAINAGE CHANNELS

### Drainage channels

Whether you are interested in façade drainage, door connections or draining water on patios: PROCOLINE is always a great choice. The channels made of high-quality, sea water-proof materials practically adapt to all situations. The PROCOLINE drainage channels also stand out visually.

PROCOLINE enables fast and effective drainage of water building up or getting in. High-quality materials and a sturdy geometry ensure that PROCOLINE also withstands high loads easily.

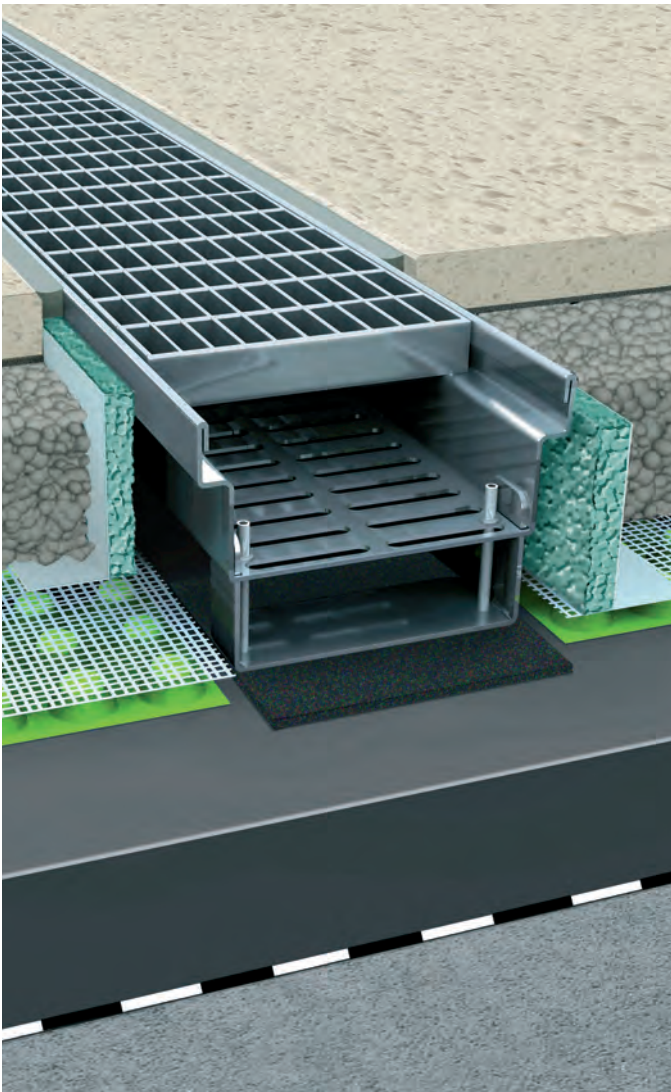

**Drainage line housing**

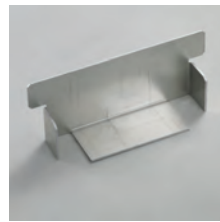

**Side walls**



**Height adjustment elements**

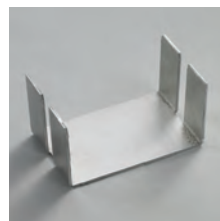

**Connector**

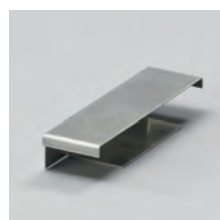

**End cap**



All products and detailed information all around the outdoor topic can be found in our outdoor price list



DOWNLOAD HERE



Subscribe to us on YouTube and stay up to date!



Subscribe  
to our  
Newsletter  
now

**Proline Systems GmbH**  
Kratzenburger Landstr. 11–15  
56154 Boppard – Germany  
Phone +49 6742 8016 0  
E-mail [info@proline-systems.com](mailto:info@proline-systems.com)  
Internet [www.proline-systems.com](http://www.proline-systems.com)

