

PROLINE

PROCHANNEL

DRAINAGE SYSTEMS
FOR FLOOR-LEVEL SHOWERS





Shower drainage

DRAINAGE AS A MODULAR SYSTEM

The most important design elements in bathroom design nowadays include floor-level showers as well as the associated drainage systems. The less the drainage is visible, the better. Purists as well as proponents of linear architecture are of this opinion. "Accessibility" has a very practical aspect in this context, as the hygienic cleaning and use of a shower can be significantly improved with less edges and corners. The "integral design" of the PROLINE drainage systems merges the floor or wall as well as drainage into a harmonious unit.

Regardless of which version you prefer, all drainage systems from PROLINE are perfect into the last detail and provide reliable safety when professionally installed, and combined with the special PROFOLIO sealing system - Made in Germany.

PROCHANNEL guaranteed

- Low installation heights
- Hygienic cleanliness, as easy to clean
- Design variety based on different installation versions
- Four system versions to choose from
 - PROCHANNELd-line
The drainage system that can be individually shortened
 - PROCHANNELw-line
The drainage system for the wall
 - PROCHANNELs-line
The drainage system for primary and secondary drainage
 - PROCHANNELp-line
The proven alternative product for primary drainage

The four PROCHANNEL versions

Drainage that can be individually shortened with PROCHANNELd-line (see p. 6-9)

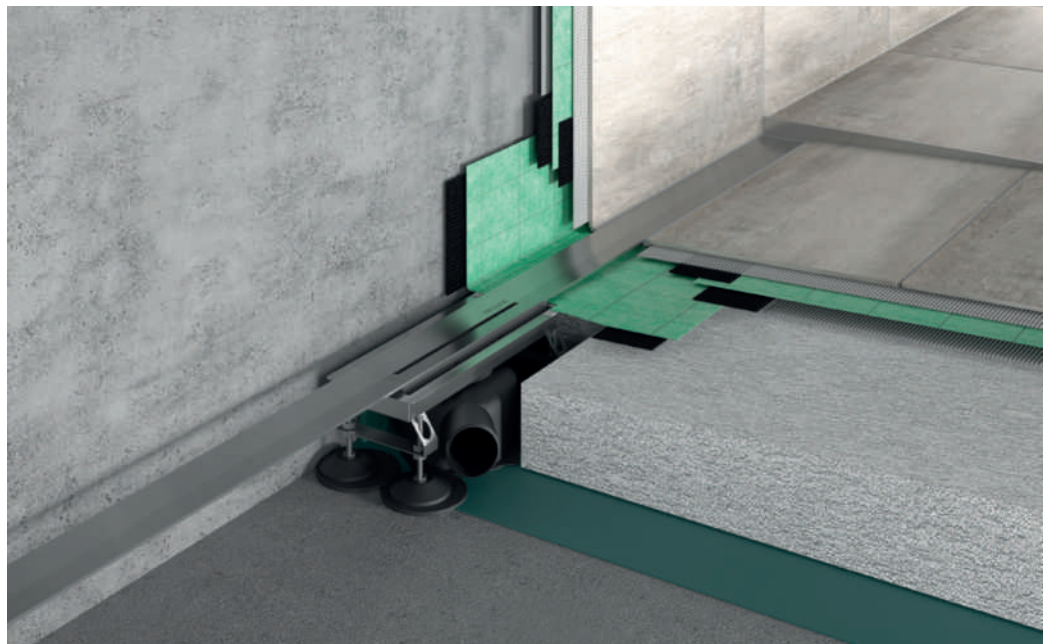

Wall drainage with PROCHANNELw-line (see p. 10-13)

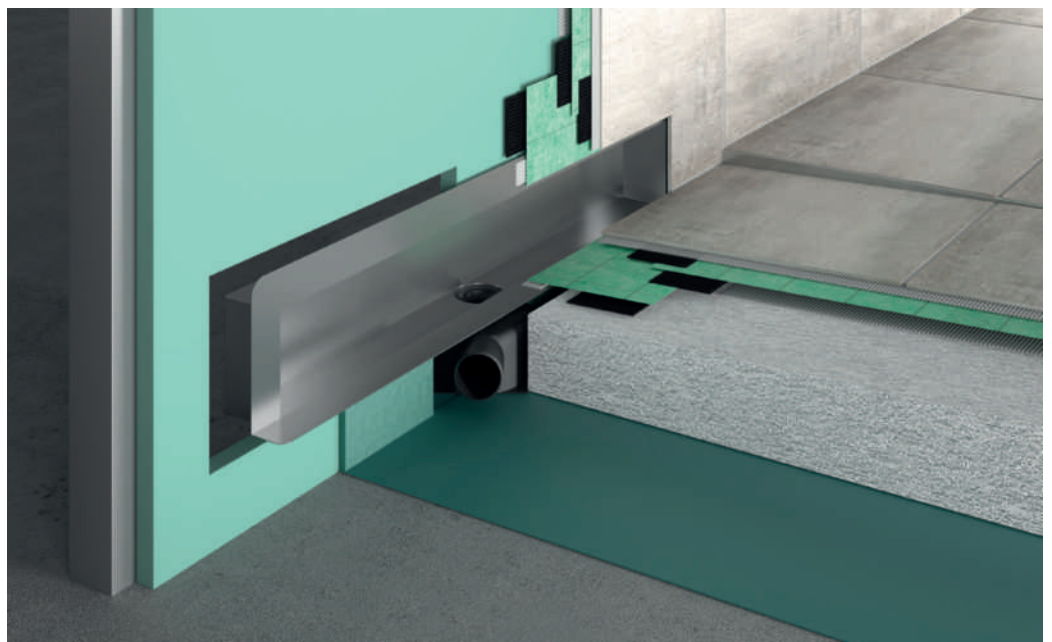

Primary and secondary drainage with PROCHANNELS-line (see p. 14-17)

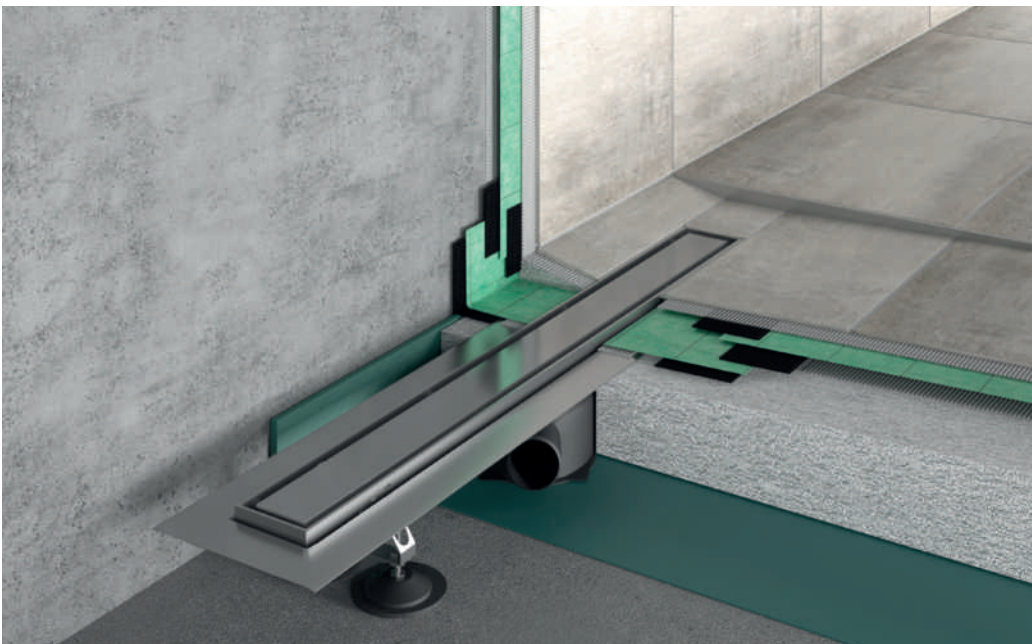

Proven primary drainage with PROCHANNELp-line (see p. 18-19)

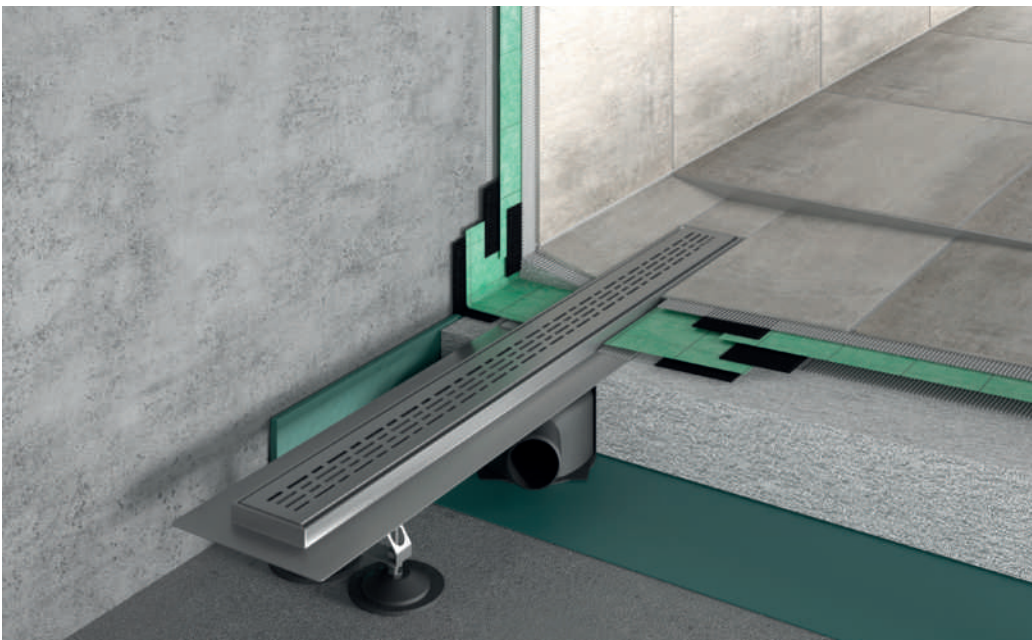

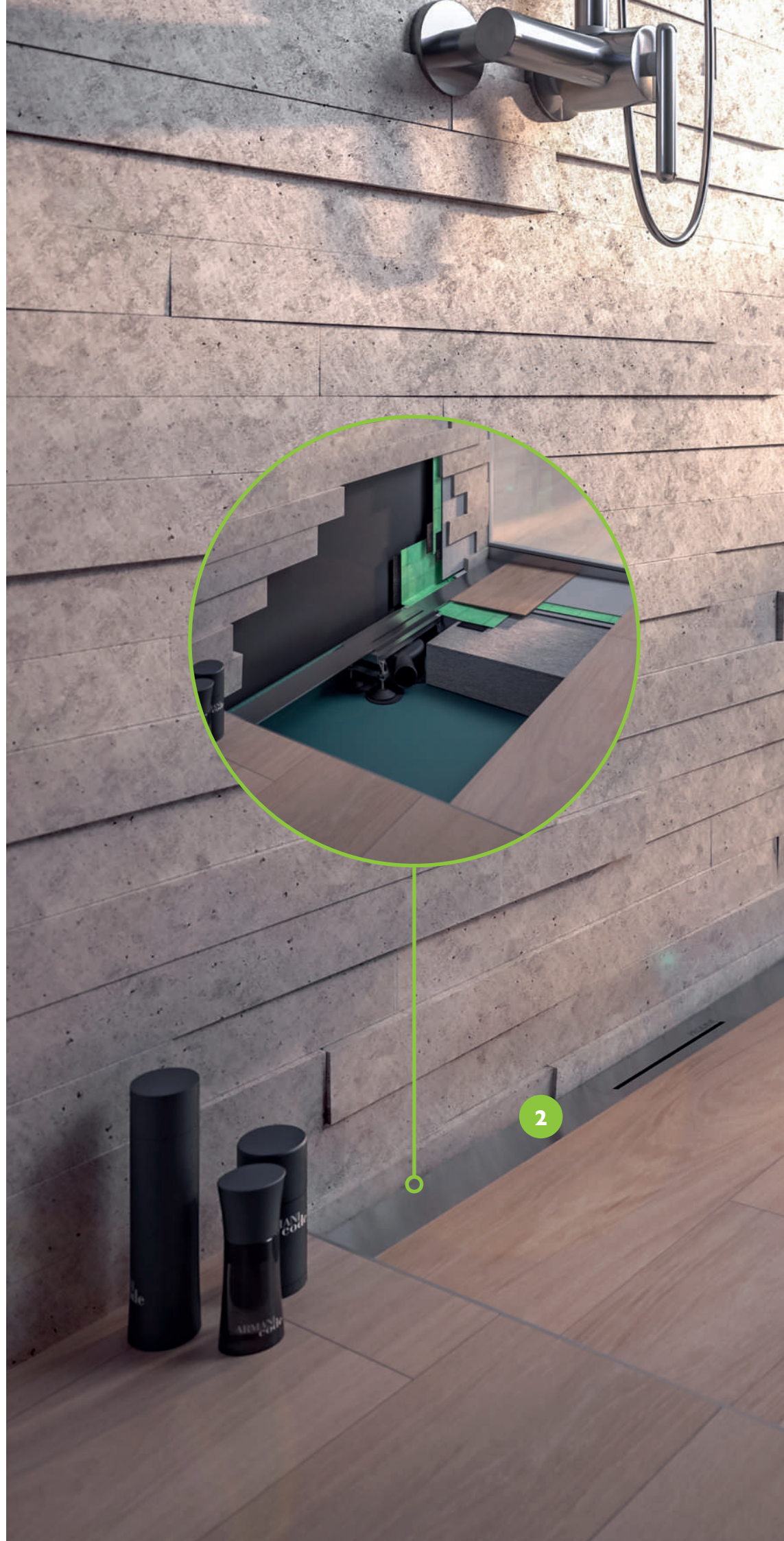
**1.****Flush installation in the niche – can be individually shortened**

Our design line impresses with filigree design as well as the option to position the drainage flush in the niche. This means you can install the drainage line along the entire width without lateral tiles. As the "drainage profile" can be shortened individually, specific dimensions can be considered (maximum length 1,200 mm).

2.**Height-adjustable – hygienic and easy to clean**

Due to integrated cascade height adjustment, different tile heights can be easily installed. The profile cover can be removed without tools using the push function, and the drainage line housing can be easily cleaned.

PROCHANNELd-line

DRAINAGE THAT CAN BE INDIVIDUALLY SHORTENED

I

Quick reader:

- Drainage line with shower profile that can be individually shortened (from 25 / 53 mm, without / with foot holder)
- Drainage line housing and shower profile made of high-quality brushed stainless steel
- Suitable for tiled and natural stone floors
- Simple cleaning for perfect hygiene

PROCHANNELd-line

THE MOST IMPORTANT INFORMATION AT A GLANCE

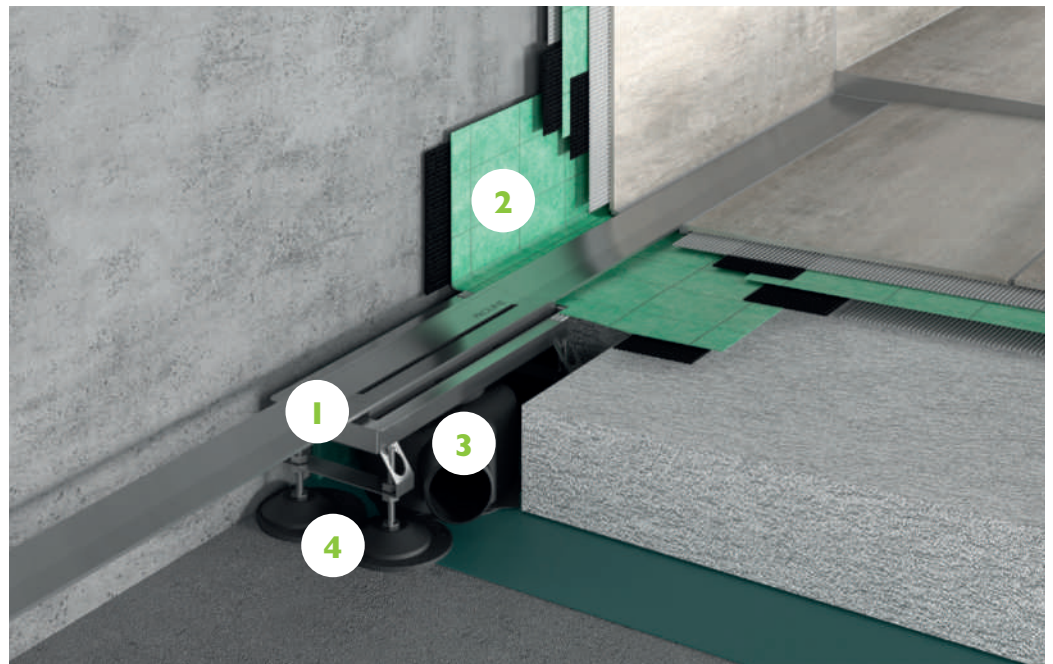

1. Drainage line incl. shower profile with welded on s-line frame for height adjustment for tile thicknesses of 10-17 mm. With its special "push function", the profile cover can be removed by hand without auxiliary means. With its technical design and the selected materials, it can be cleaned hygienically quickly and easily. The internal gradient optimises water drainage, which results in an additional self-cleaning effect.

2. The drainage line housing of the PROCHANNELd-line is equipped with a permanently bonded sealing collar. The sealing of wall and floor areas is made easy with this sealing collar.

3. The PROCHANNEL drain fitting is not included in the scope of delivery. Selection of the drain fitting depends on the discharge water from your shower fitting and the existing installation height. An overview of our drain fittings can be found on page 22.

4. The drainage line can be lifted and installed at the desired height by means of the installation feet included in the delivery.

For more information, visit our YouTube channel:



PROCHANNELd-line at a glance

Installation solution flush in the niche

Can be installed flush to the wall, close to the wall or in the surface.

Push function

Enables fast and simple cleaning of the drain - without additional tools.

Can be individually shortened

The shower profile can be optimally adapted to the width of your shower.

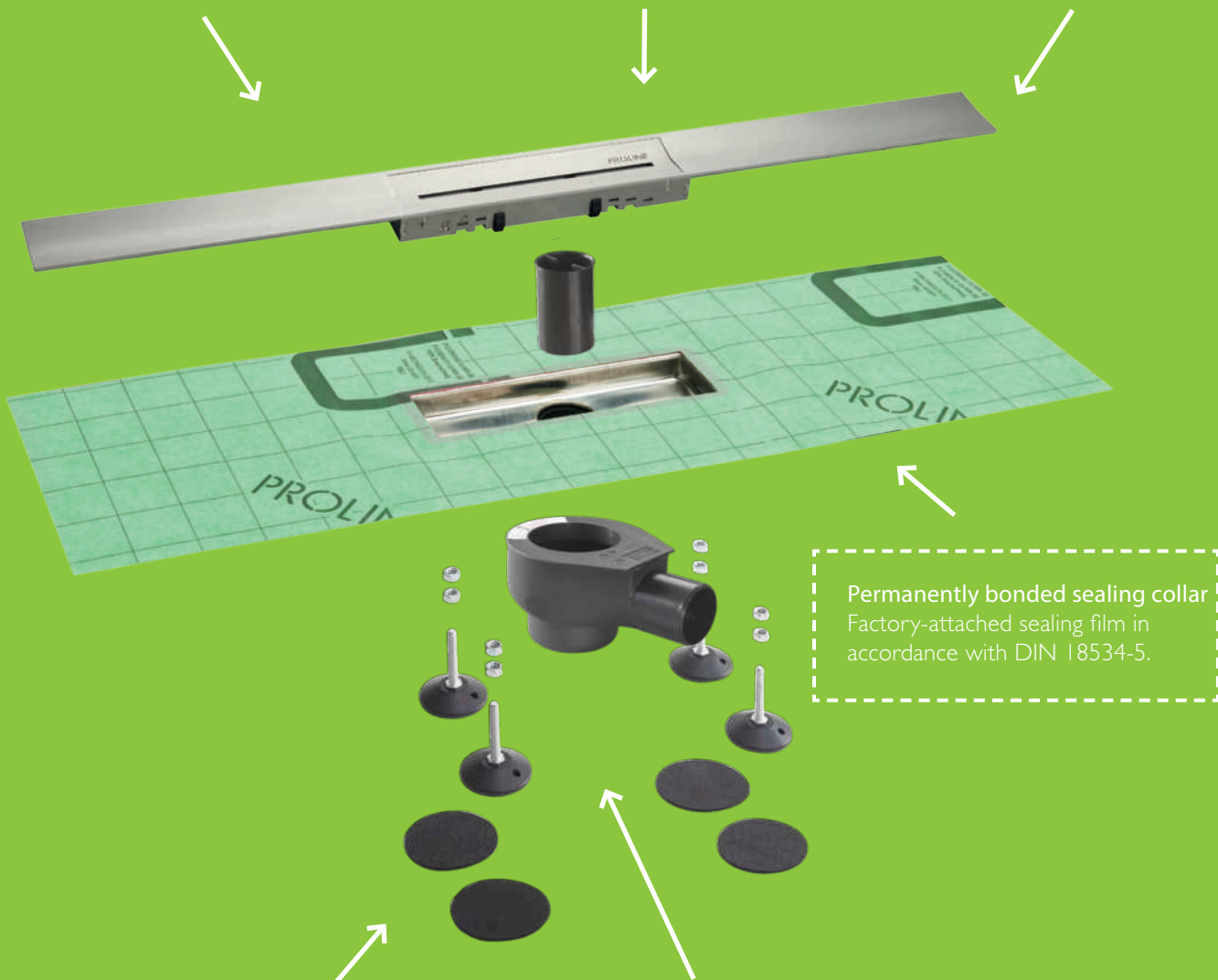

Permanently bonded sealing collar

Factory-attached sealing film in accordance with DIN 18534-5.

Individual height adjustment

The height can be individually adjusted with the installation feet.

Drain fitting (not included in scope of delivery)

Drain fittings can be individually selected and rotated by 360 degrees (see page 22).



1. Integral design

What better in the bathroom than making technology invisible? With the w-line from PROLINE, you can make this a reality. The shower drainage is laid in the wall. This gives your shower a uniform, continuous base. This pays off in particular with large-format tiles or natural stone slabs, where a harmonious tile pattern is key.

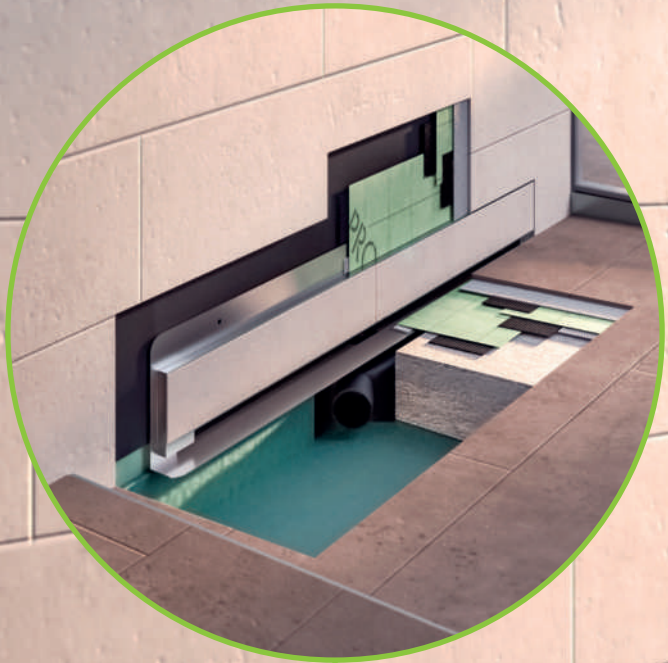

2. Invisible drain

The only visible part of the drain is the cover. Choose between the versions "steel design cover made of brushed stainless steel" or "tile recess", which incorporates your desired ceramic, thus completing the experience of an invisible shower drainage.

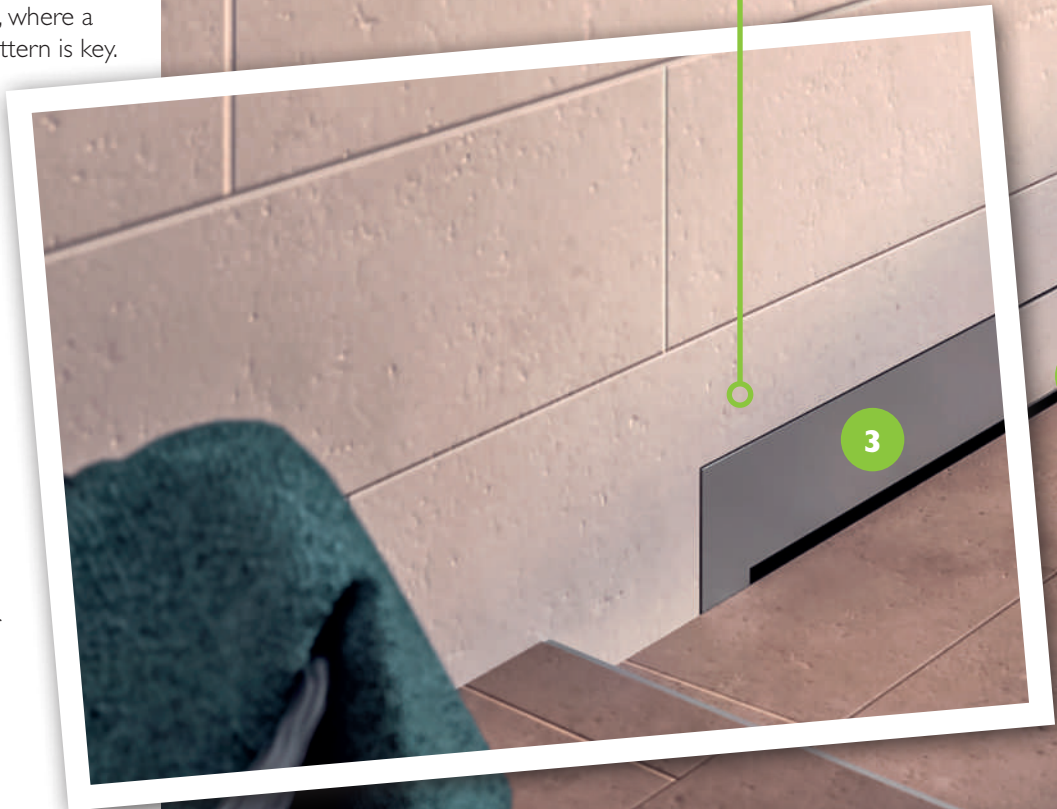

3. Stainless steel

The complete drainage line housing of the PROCHANNELw-line drainage is made of high quality stainless steel, thus meeting even the highest demands.

PROCHANNELw-line

WALL DRAINAGE

Quick reader:

- Low installation height (from 13 mm)
- Drainage line housing made of high quality stainless steel
- Suitable for tiled and natural stone floors
- Certified sealing system with abP
(= general building approval test certificate)

PROCHANNELw-line

THE MOST IMPORTANT INFORMATION AT A GLANCE

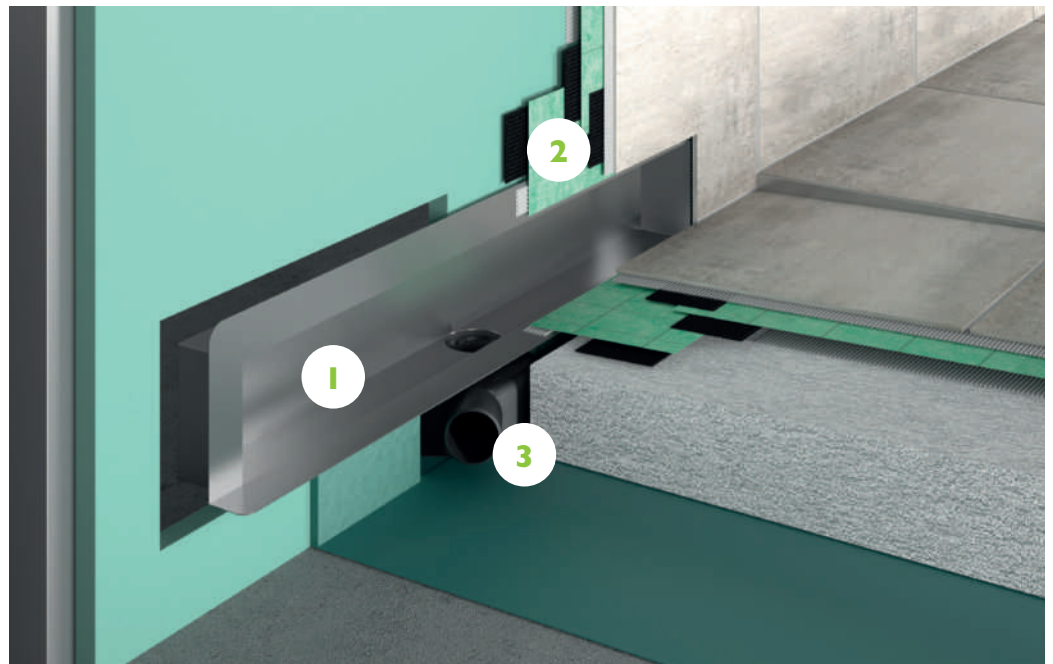

1. With the PROCHANNELw-line, you have a choice between 2 covers, the tile recess and the steel design cover made of brushed stainless steel. The tile recess version gives you the option to make your drain channel virtually invisible. The drainage line housing, steel design cover as well as the tile recess are made of stainless steel, thus providing excellent hygienic properties.

2. The drainage line housing of the PROCHANNELw-line is equipped with a permanently bonded sealing collar. The sealing of wall and floor areas is made easy with this sealing collar.

3. The PROCHANNEL drain fitting is not included in the scope of delivery. Selection of the drain fitting depends on the discharge water from your shower fitting and the existing installation height. An overview of our drain fittings can be found on page 22.

For more information, visit our YouTube channel:



PROCHANNELw-line at a glance

Individual design

You have a choice between steel design cover (a) or tile recess (b).

Permanently bonded sealing collar

Factory-attached seal in accordance with DIN 18534-5.

(a) Steel design cover

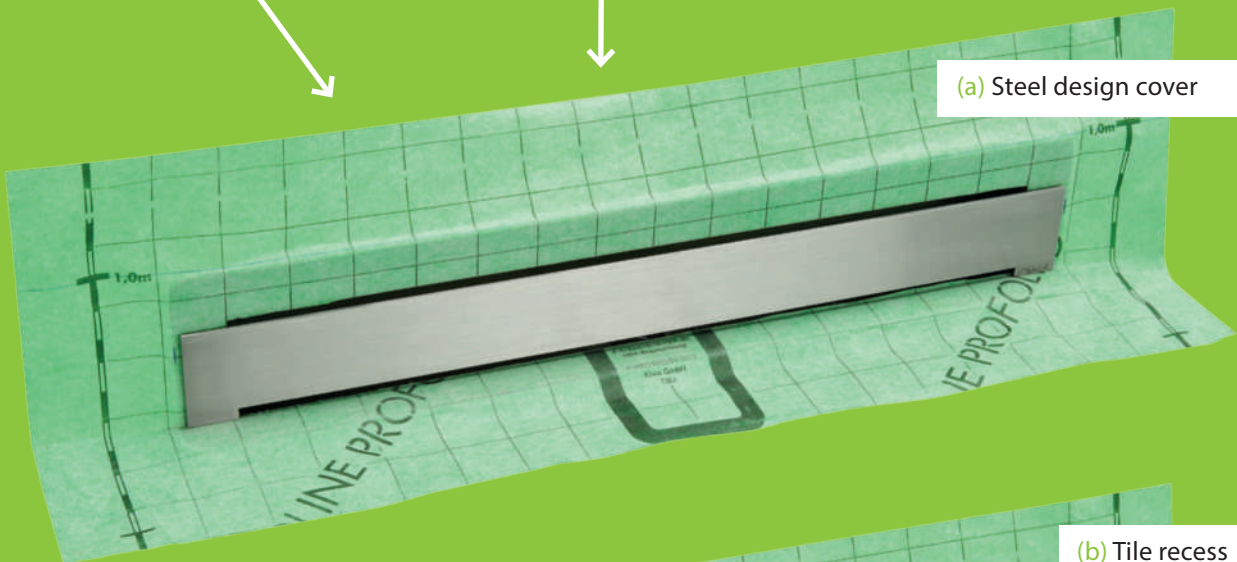

(b) Tile recess

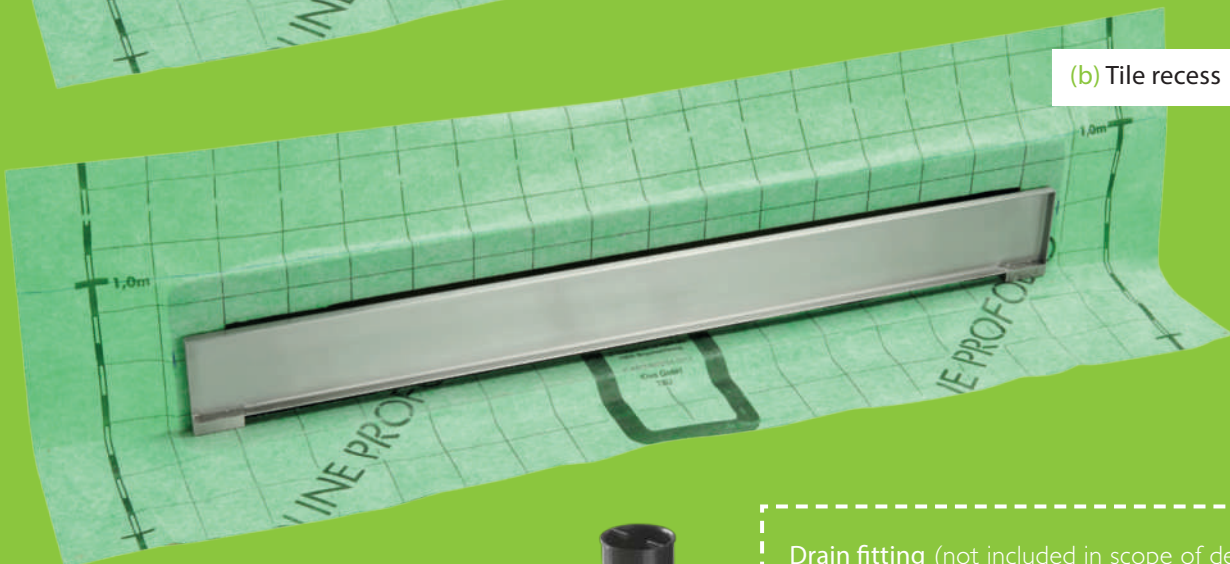

Self-cleaning effect

The internal gradient inside the drainage line housing optimises water drainage.

Drain fitting (not included in scope of delivery) Drain fittings can be individually selected and rotated by 360 degrees (see page 22).



1.

Maximum design options

The PROCHANNELs-line is available in 6 different lengths and provides 4 different cover options. A particularly stylish version is the shadow joint, which you can create by means of the support element. But the tile recess, which can be installed upside down as design grille steel, is no less elegant – just like the timeless cover with the classic design grille.

2.

Leak tightness

The PROFOLIO sealing system, specifically designed for PROCHANNEL, ensures the sealing of your on grade shower (also see page 20). Just like the PROCHANNEL drainage system, this is a comprehensive system which does not require any additional materials.

3.

Regulations DIN 18534

The planning and design of the correct sealing of interior areas is regulated in Germany by DIN 18534. Waterproofing membranes, the correct width of bonding flanges for example are set down here.



PROCHANNELs-line

PRIMARY AND SECONDARY DRAINAGE

3

Quick reader:

- Low installation height (from 17 / 52 mm, without / with foot holder)
- Drainage line housing made of high-quality stainless steel
- Adjustable to covering heights of 10-17 mm due to cascade adjustment
- Certified sealing system with abP (= general building approval test certificate)
- Tested sound protection surveys up to SST III



Support element for shadow joint



Steel design grille
Tile recess



Classic design grille



PROCHANNELS-line

THE MOST IMPORTANT INFORMATION AT A GLANCE

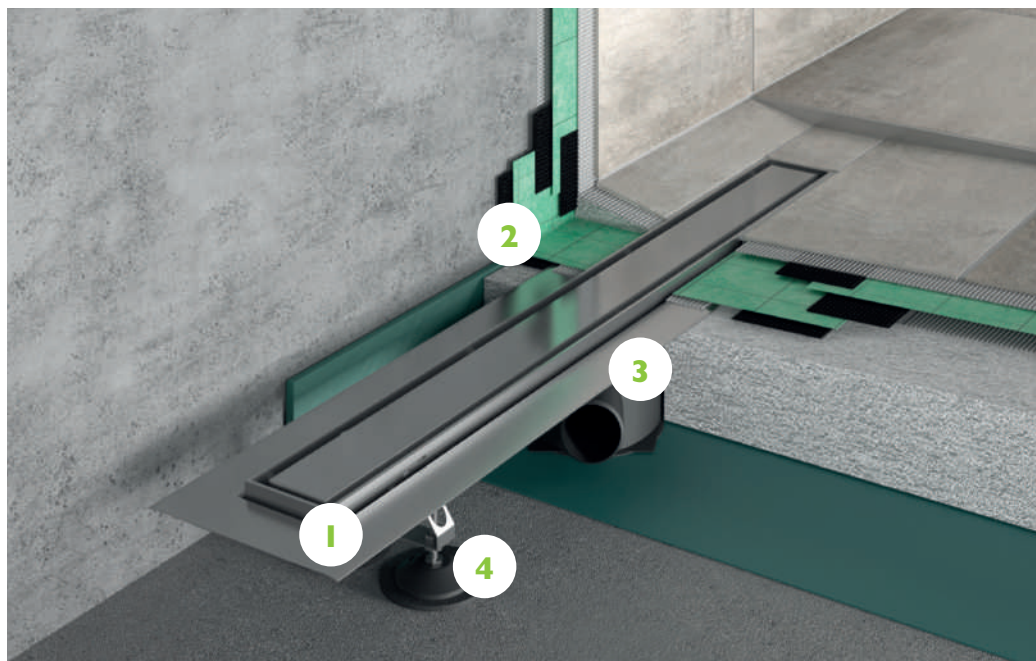

1. The PROCHANNELS-line gives you four options when choosing a cover; the PROCHANNEL tile recess and steel design grille (as shown in image above) – with two-sided use, as well as the PROCHANNEL classic design grille or the PROCHANNELS-line support element for forming a shadow joint.

2. The drainage line housing of the PROCHANNELS-line is available with or without a permanently bonded sealing collar. The factory-attached sealing collar facilitates sealing of the floor area. PROCHANNELS-line also gives you the option to order a pre-assembled system package incl. drain fitting and installation feet (see PROLINE price list).

3. The PROCHANNEL drain fitting is not included in the scope of delivery. Selection of the drain fitting depends on the discharge water from your shower fitting and the existing installation height. An overview of our drain fittings can be found on page 22.

4. The drainage line can be installed at the desired height using the installation feet.

For more information, visit our YouTube channel:



PROCHANNELS-line at a glance

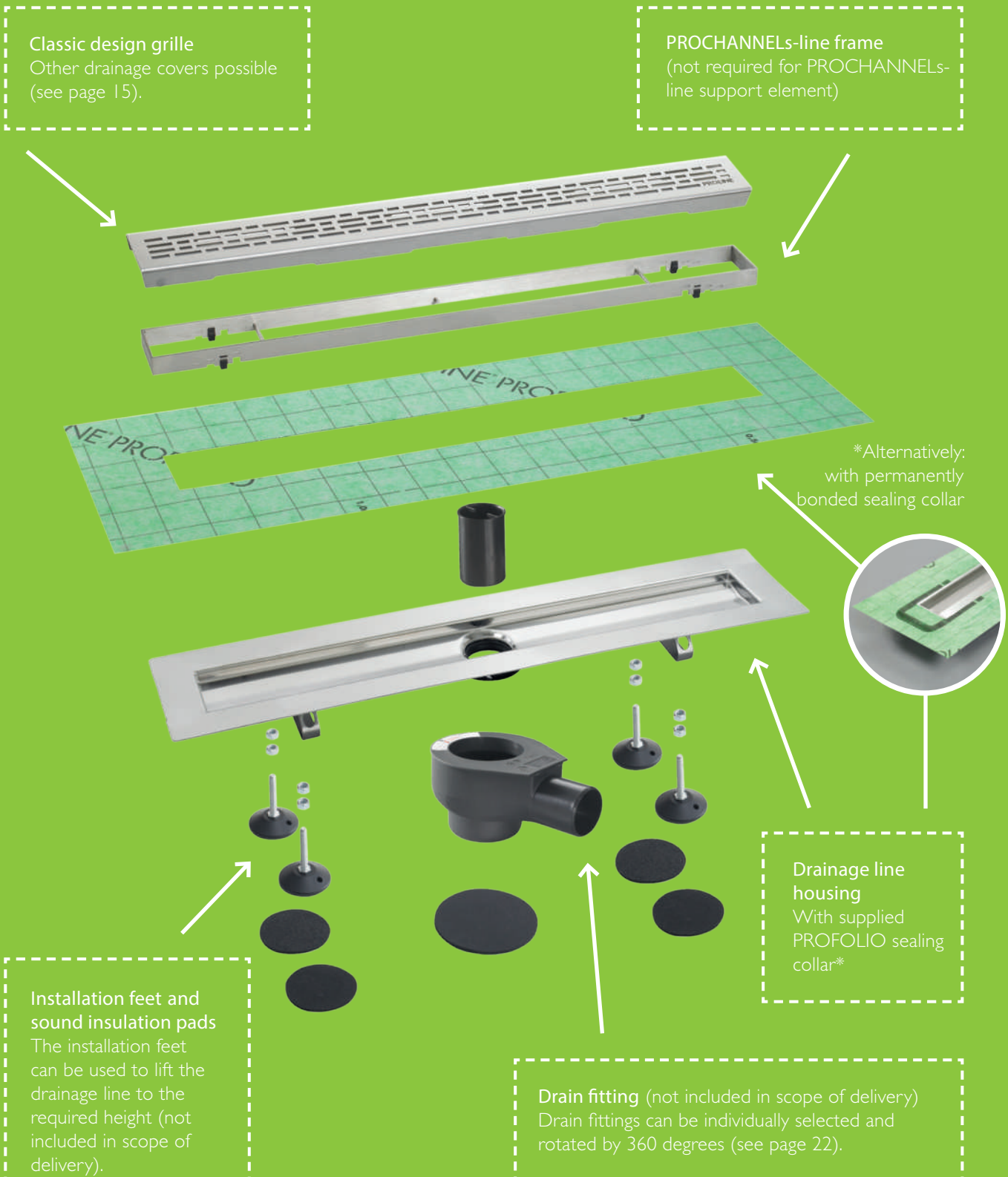

1.

Simple, but also simply good

With this model, the shower water, which is primarily also called surface water, is received across the entire length of the drainage line housing, and fed to the drain via the internal gradient. With upstands for tile flooring up to 12.5 mm thickness.

2.

Hygiene concept

The closed, straight drainage line housing can be easily cleaned, thus ensuring the highest degree of hygiene safety. The system is therefore very popular in the hotel industry, sports facilities but also private housing.

3.

Systemic solution

Different lengths of the drainage housing (70-150 cm) can be combined with different drainage covers as well as drain fittings for your customised, perfect drainage solution.

The proven PROLINE sealing system PROFOLIO ensures professional tightness of the wet area in accordance with DIN 18534.



PROCHANNELp-line

PROVEN PRIMARY DRAINAGE

2

Quick reader:

- Low installation height (from 14 / 52 mm, without / with foot holder)
- Drainage line housing made of high quality stainless steel
- Also suitable for large tile formats
- Certified sealing system with abP (= general building approval test certificate)
- Tested sound protection surveys up to SST III



Tile recess



Steel design grille



Classic design grille

Sealing of the system

Certified sealing system:
PROFOLIO



The OTTOCOLL M500 adhesive tested in the system is suitable for the bonding of

- Sealing collars on drainage line housing
- Tiles/natural stone in the tile recess
- Tiles/natural stone on the support element and recommended by us.



PROFOLIO sealing and uncoupling film made of polyethylene



PROFOLIO sealing tape



OTTOCOLL M500 Hybrid adhesive and sealing compound

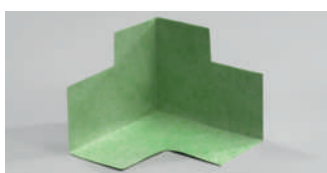

PROFOLIO sealing tape corners
Inside corner

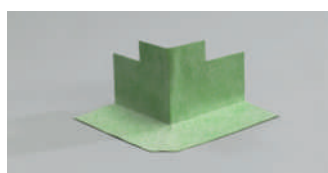

Outside corner



PROFOLIO
butt-joining tape

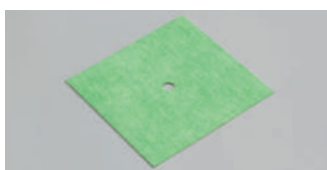

PROFOLIO sealing collars
Wall collar



Floor collar

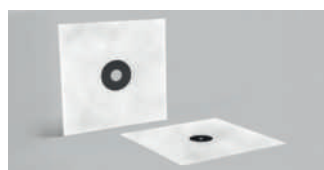

PROFOLIO sealing collars
with expansion zone

Additional products



PROFOLIO tub sealing tape
with cut and noise protection
finish



PROFOLIO
Tub sealing tape with noise
protection finish



PROBAND
Butyl sealing tape,
self-adhesive



PROFOLIO compensation corners
Compensation corner left

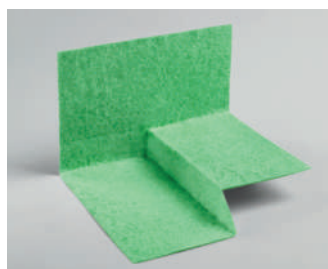

Compensation corner right

Accessories

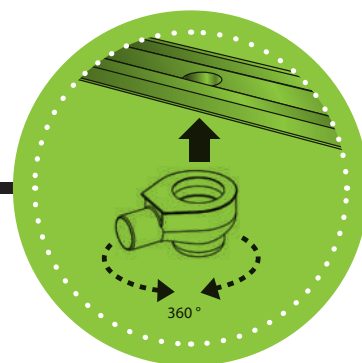

PROCHANNEL drain fittings

For rotatable installation on the drainage line housing



0.7 l/s / DN 50



0.8 l/s / DN 50



1.2 l/s / DN 70



1.3 l/s / DN 50

Horizontal connection

Maximum drain	0.7 l/s	0.8 l/s	1.2 l/s
Connection	DN 50	DN 50	DN 70
Standard-compliant drainage	-	Yes	Yes
Min. installation height (mm)*	81	106	134
Min. installation height (mm)**	84	110	138
Sealing water high (mm)	25	50	60
Item no.	95340	95341	95344

PROCHANNEL drain fittings

For rotatable installation on the drainage line housing

Vertical connection

Maximum drain	1.3 l/s
Connection	DN 50
Standard-compliant drainage	Yes
Min. installation height (mm)*	14 / 52 without / with base holder
Min. installation height (mm)**	17 / 52 without / with base holder
Sealing water high (mm)	50
Item no.	95342

PROCHANNEL drain fitting super flat

Drain fitting made from plastic suitable for all PROCHANNEL drainage lines with particularly low installation height

Side connection

Maximum drain	0.5 l/s
Connection	DN 40
Standard-compliant drainage	-
Min. installation height (mm)*	55
Min. installation height (mm)**	59
Sealing water high (mm)	30
Item no.	95343



0.5 l/s / DN 40

* Min. installation height [mm] refers to installation with PROCHANNELp-line (measured up to fixed flange)

** Min. installation height [mm] refers to installation with PROCHANNELs-line or PROCHANNELd-line (measured up to fixed flange)
CAUTION: Please consider the height of the upstand for PROCHANNELp-line of 15 mm tiles

PROCHANNEL profiles

Made of stainless steel (V2A)



Glass carrier profile



Glass carrier profile with slope profile



Glass carrier profile U

PROCHANNEL slope profile

Made of stainless steel (V2A)

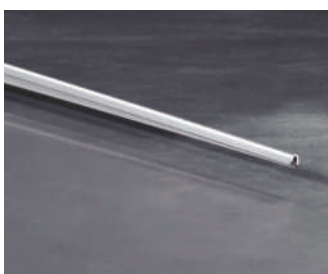

Left slope profile



Right slope profile



Slope profile with PROFLOOR

Further products

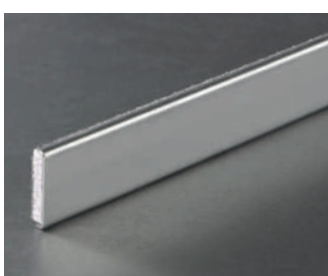

Wall cover



Hair sieve



Installation feet

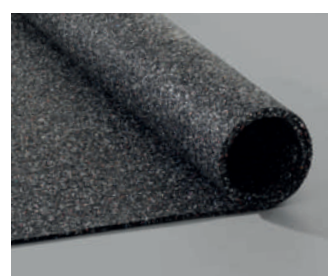

Sound insulation mat

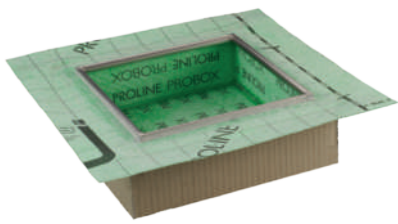

Order plays an important part for each conscious or subconscious routine. With a bit of organisation, you achieve great satisfaction, as nothing is more annoying than disorder and chaos. For everything in your bathroom being close to hand and well organised, we have developed the wall niche PROBOX as well as the PROSHELF shelves. Whether it is for new builds, renovations or refurbishments: We provide you with universal solutions in different shapes and sizes for every room, every ceramic, natural stone as well as all conceivable situations. Still cannot find something that fits? No problem: We will be pleased to produce your desired configuration to the millimetre from lot size 1, and that is a promise.

PROBOX explained
in 60 seconds



PROBOX – more than just a wall niche

LIGHT STRIP & CHARGING STATION FOR SMARTPHONE



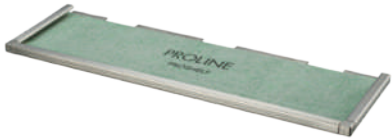
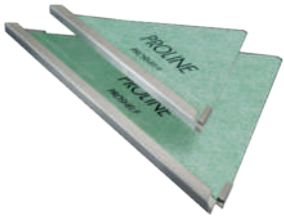

With PROSHELF, you will have everything you need at your fingertips in shower & bath. These universal shelves can even be installed retrospectively in the corner or on the wall. The existing joint is simply used for this.

PROSHELF at a glance



PROSHELF – space creator in many shapes

TRIANGLE-, RECTANGLE-, TRAPEZE & DIAMOND SHAPES





Subscribe to us on YouTube and stay up to date!



Subscribe
to our
newsletter



Proline Systems GmbH

Kratzenburger Landstr. 11-15

56154 Boppard – Germany

Phone +49 67 42/80 16-0

E-mail info@proline-systems.com

Internet www.proline-systems.com

Follow us on:

